

# PRODUCT DATASHEET

## SF COMPACT IK10 300 24 W 3000 K IP65 WT

SURFACE COMPACT IK10 | Wall and ceiling luminaire with high impact resistance



---

### Areas of application

- Corridors
- Stairways
- Bathrooms
- Foyers
- Public areas

---

### Product benefits

- Slim profile
- Resistance against vandalism
- High luminous efficacy
- Very homogenous light
- LED protected for safe installation
- 5 years guarantee

---

### Product features

- Beam angle: 120°
- Type of protection: IP65
- Impact resistance: IK10
- Housing and cover made from polycarbonate



- Glow Wire Test according to IEC 60695-2-12: 850 °C
- Through-wiring possible



## TECHNICAL DATA

### Electrical data

Nominal wattage	24.00 W
Nominal voltage	220...240 V
Mains frequency	50...60 Hz
Nominal current	110 mA
Inrush current	15.6 A
Inrush current time $T_{h50}$	620 $\mu$ s
Max. no. of lum. on circuit break. B16 A	30
Max. no. of lum. on circuit break. C10 A	28
Max. no. of lum. on circuit break. C16 A	45
Power factor $\lambda$	$\geq 0.90$
Total harmonic distortion	< 20 %
Protection class	II
Operating mode	Integrated LED driver

### Photometrical data

Luminous flux	1800 lm
Luminous efficacy	75 lm/W
Color temperature	3000 K
Light color (designation)	Warm White
Color rendering index Ra	> 80
Standard deviation of color matching	$\leq 4$ sdc <sub>m</sub>
Luminous intensity	-
Low flicker	Yes
Flickering metric (Pst LM)	-
Stroboscope effect metric (SVM)	-
Photobiological safety group acc. to EN62778	RG0
Beam angle	120 °



0.5	1.58 1.56	E(0°) 2480 E(C90) 192 E(C0) 194
1.0	3.15 3.13	E(0°) 620 E(C90) 48 E(C0) 49
1.5	4.73 4.69	E(0°) 276 E(C90) 21 E(C0) 22
2.0	6.30 6.25	E(0°) 155 E(C90) 12 E(C0) 12
2.5	7.88 7.82	E(0°) 99 E(C90) 8 E(C0) 8
3.0	9.45 9.38	E(0°) 69 E(C90) 5 E(C0) 5
Distance [m]	Cone diameter [m]	Illuminance [lx]
— C0/C180 (Half beam angle [°]: 114.8°) — C90/C270 (Half beam angle [°]: 115.2°)		

LDC typ cone

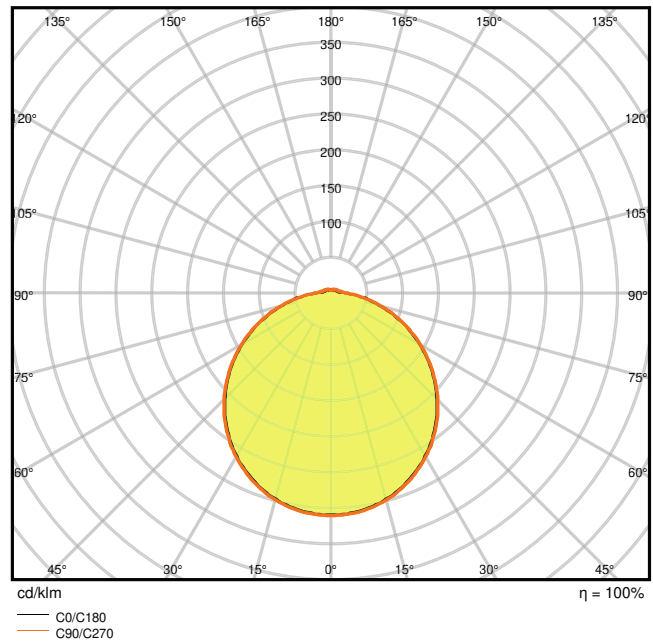

LDC typ polar

### Dimensions & Weight

Diameter	300.00 mm
Height	61.00 mm
Product weight	940.00 g

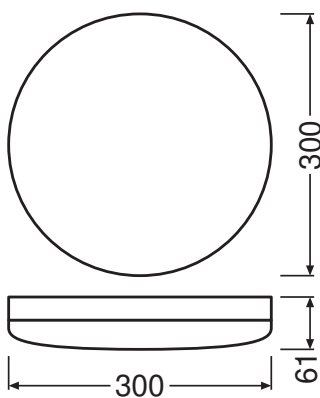

## Materials & Colors

Product color	White
Housing color	White
Body material	Polycarbonate (PC)
Cover material	Polycarbonate (PC)
Light emitting surface material	Polycarbonate (PC)
Glow Wire Test according to IEC 60695-2-12	850 °C
Mercury content	0.0 mg

## Application & Mounting

Ambient temperature range	-20...+50 °C
Type of connection	Screwless terminal, 3-Pole
Type of protection	IP65
Protection class IK (shock resistance)	IK10
Dimmable	No
Mounting type	Surface
Mounting location	Ceiling / Wall
Application environment	Indoor
LED module replaceable	Not replaceable
With light source	Yes

## Lifespan

Lifespan L70/B50 at 25 °C	50000 h
Lifespan L80/B10 at 25 °C	30000 h
Lifespan L90/B10 at 25 °C	15000 h
Number of switching cycles	100000

## Control gear

Output current	280 mA
----------------	--------

## Certificates & Standards













Standards	CE / CB / ENEC / TÜV SÜD / EAC
Luminaire with limited surface temperature, "D sign"	Yes
Ball shot safe	No

## Additional product data

Number of illuminants	-
-----------------------	---



DOWNLOAD DATA

DOWNLOAD DATA	
	User instruction
	Addon Technical Information
	Tender documents
	Certificates
	Declarations Of Conformity CE
	Declarations Of Conformity CE
	On-Pack-Info
	IES file (IES)
	LDT file (Eulumdat)
	M3D file (3D Model)
	ULD file (DIALux)
	UGR file (UGR table)

LOGISTICAL DATA

Product code	Packaging unit (Pieces/Unit)	Dimensions (length x width x height)	Gross weight	Volume
4058075062207	Folding box 1	65 mm x 304 mm x 304 mm	1073.00 g	6.01 dm <sup>3</sup>
4058075062214	Shipping box 8	555 mm x 320 mm x 325 mm	9477.00 g	57.72 dm <sup>3</sup>

The mentioned product code describes the smallest quantity unit which can be ordered. One shipping unit can contain one or more single products. When placing an order, for the quantity please enter single or multiples of a shipping unit.

ADDITIONAL CATALOG INFORMATION



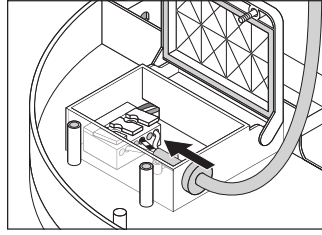
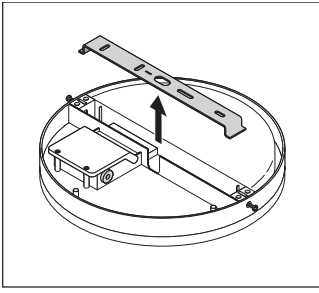

---

### References / Links

- For Guarantee see [www.ledvance.com/guarantee](http://www.ledvance.com/guarantee)

---

### DISCLAIMER

Subject to change without notice. Errors and omission excepted. Always make sure to use the most recent release.

